



eoProbe™

DESCRIPTION

Kapteos electro-optic probes eoProbe™ give you access to a complete measurement of the electric (E) field, in both frequency and time domains for single-shot or repetitive signals, whatever the environmental conditions and the measurement constraints: > 1 MV, > 40 kA, > 5 T, reactive near field area, vacuum, high pressure, ultra confined space, in biological tissues measurements, < 1 kHz and > 10 GHz, coupled physical effects like 1 kW CW at 100 MHz with 3T static magnetic field...

Any E field probe or receiving electric antenna can be substituted by an electro-optic probe associated with its optoelectronic converter eoSense™. This converter is used to feed the probe with a laser beam and then to convert the optical information carried by the laser beam into an electric signal. This electric signal gives you the true temporal evolution of a single component of the measured E field. Owing to its fully dielectric composition based on ultra low loss tangent materials, eoProbe™ do not interfere at all with the E field to be measured.

With this new line of electro-optic transducers, the permanent power handling has been enhanced by a factor of 10 and a cubic base has been added for a better usability. Based on quartz and ceramics, electro-optic probes have to be handled with care and mechanical shocks must be avoided.

APPLICATIONS

When not in the far field conditions, the key point for achieving a true value of the E field is to use a field probe with no galvanic link and a permittivity close to the one of the medium of measurement. This is the reason for which we offer three lines of probe:

- **vac** line for measurements in vacuum (down to 10^{-5} mbar) or at high pressure (up to 15 bar),
- **air** line for measurements at atmospheric pressure or at low pressure in low permittivity media like air or oils,
- **bio** line for measurements in high permittivity media like aqueous liquids and biological tissues.

Depending on your setup and on the E field component you are interested in, you can use two different types of probe leading to a specific component of the E field to be measured:

- **longitudinal** probes (EL type) for an E field component parallel to the probe axis,
- **transverse** probes (ET type) for an E field component perpendicular to the probe axis.

Depending on what you seek, either sensitivity, spatial resolution or high frequency, two different lengths of transducer can be used:

- short transducer (1 mm long) leading to high spatial resolution and high frequency probes,
- long transducer (5 mm long) leading to high sensitivity probes with lower spatial resolution.

Depending on your need, you have finally the choice among 12 different configurations of probe manufactured with 5 metres of optical fibre length as standard.

SERVICES

Kapteos offers a recalibration service of your probes and associated optoelectronic converters. Specific calibration in different liquids are also possible on request. Each probe is delivered with a routine test report valid for 2 years.

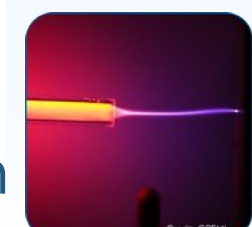
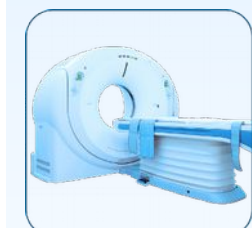
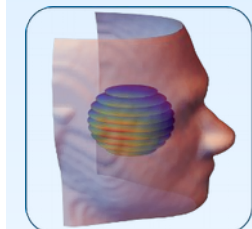
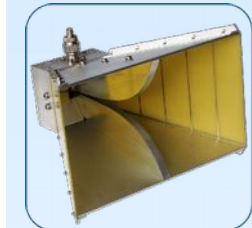
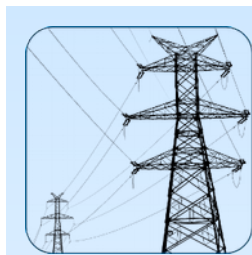

Your key partner for electromagnetism
in harsh environment

LINES	air	bio	vac
Applications: for measurement	at atmospheric pressure down to low vacuum (1 hPa or 1 mbar) and in low permittivity liquids (oils)	in aqueous, biological tissues and high permittivity liquids	in medium to high vacuum (down to 1 mPa or 10 ⁻⁵ mbar) for high pressure up to 15 bar
Fibre length	5 m	5 m	5 m
Vacuum feed-through	NA	NA	located at > 1 m distance from connector and probe tip, crimped on the fibre sheath
Vacuum feed-through durability ¹	NA	NA	25 matings
Overall weight (w/ 5 m fibre link)	110 ± 10 g (probe: ~ 2 g)	110 ± 10 g (probe: ~ 2 g)	140 ± 20 g (probe: ~ 2 g)

¹ After 25 matings, some wearing parts have to be replaced by Kapteos. This renewal can be done up to 4 times max.

E field (V_{rms}/m) range in frequency domain

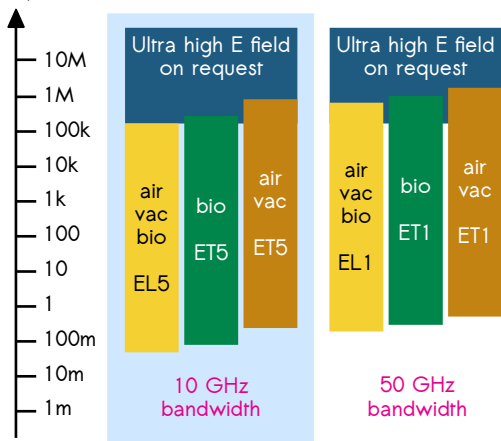

Measurement medium permittivity

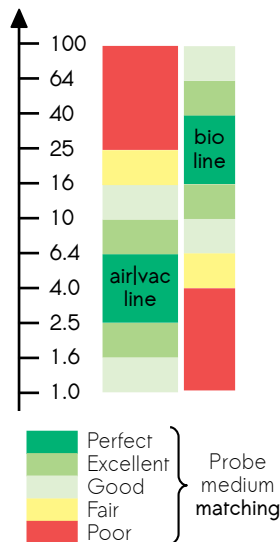

Pressure (Pa)

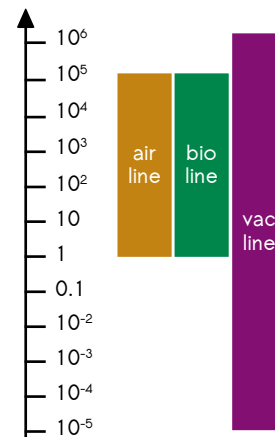

COMMON FEATURES

Dynamic range	> 130 dB.Hz
Selectivity (orthogonal components rejection)	> 50 dB
Insertion Loss	< 9 dB
Optical connector	Souriau Duplex LC/APC
Optical connector durability	500 matings
Connector repeatability	< 0.2 dB
Damage threshold	E > 10 MV/m or permanent PD ² > 10 W/cm ²
Transducer composition (probe head)	Fully dielectric, low loss materials, no metal part

² Power Density

SPECIFIC CHARACTERISTICS		EL5-air vac	ET5-air vac	EL1-air vac	ET1-air vac	EL5-bio	ET5-bio	EL1-bio	ET1-bio
FD ³ Sensitivity (mV/m.√Hz)	Typ.	40	200	160	400	40	64	160	250
	Max.	50	250	200	500	50	80	200	320
TD ⁴ Sensitivity (mV/m.√Hz)	Typ.	16	80	64	160	16	25	64	100
	Max.	20	100	80	200	20	32	80	125
P1 dB ⁵ (kV _{rms} /m)		> 50	> 250	> 200	> 500	> 50	> 80	> 200	> 320
Transducer length (mm)		5		1		5		1	
Measurement voxel		∅ ≤ 1mm, length 5 mm		∅ ≤ 1mm, length 1 mm		∅ ≤ 1mm, length 5 mm		∅ ≤ 1mm, length 1 mm	
Frequency range (Hz)		10 → 10G ⁶		10 → 50G		30k → 1G		30k → 1G	
Probe sheath permittivity ⁷		4				23			
Recommended use		Gases, Non-Polar Liquids (e.g. oils) Vacuum				Polar Liquids (e.g. water & biological media)			

³ Frequency-Domain - Sensitivity is given in air for **air|vac** lines and in pure water (deionized) for **bio** line

⁴ Time-Domain (on μ s time window) - Sensitivity is given in air for **air|vac** lines and in pure water (deionized) for **bio** line

⁵ 1-dB compression Point (in case of use of moderate gain -G30- for the optoelectronic converter eoSense)

⁶ For narrower bandwidths (e.g. 500 MHz), EL5 and ET5 probes could sometime be used even if the operating frequency is higher than 10 GHz (please ask Kapteos for details)

⁷ @1MHz - For electromagnetic simulation purpose, contact Kapteos for details

TRANSDUCER DESCRIPTION

Drawings at scale 1:1 - Dimensions in mm (± 0.1 mm on diameters unless otherwise noted) - Arrow indicating the measured E field component

air line

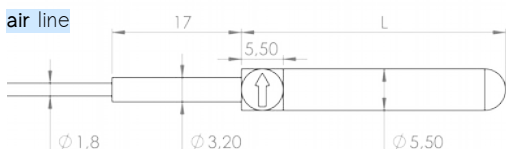

bio line

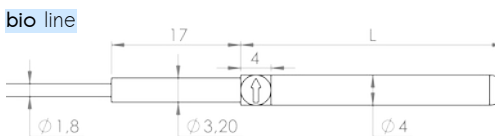

vac line

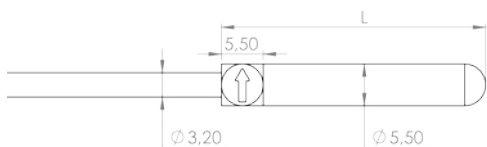

vacuum feed-through at scale (Diameter: 30 mm - Length A: 42.4 mm)

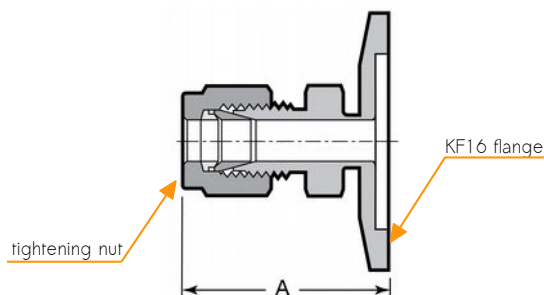

A 8-mm outer diameter, 80-mm long stainless steel pipe is crimped on the fibre sheath (not shown) for vac line

Transducer length (mm)	1	5
Overall length L ± 0.25 (mm)	31.75	34.75

CONNECTOR DESCRIPTION

Drawings true to scale - Dimensions in mm (± 0.25 mm on diameters unless otherwise noted)

connector-to-eoSense™ front view

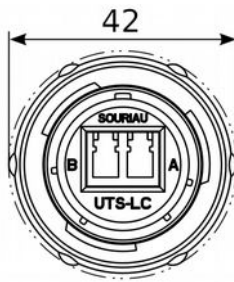

connector-to-eoSense™ side view

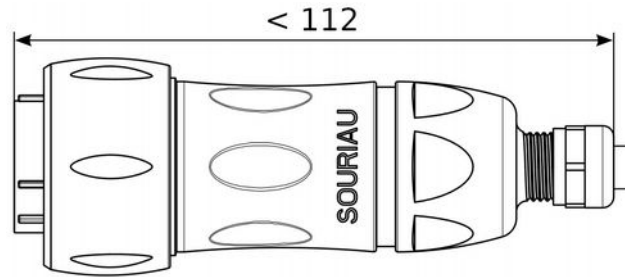

OPERATING CONDITIONS ([°] Max. 8h per day in case operating conditions are harsher than storage conditions | [°] Max. 4h in a row in pure water and 1h in salty water)

Temperature [°]	+10°C → +50°C (+50°F → +122°F)
Pressure [°]	0-2030 hPa (0-29.4 psi)
Bending radius [°]	40 mm min.
Ingress Protection rating [°]	IP67 (probe only)
Probe cleaning	Use cloth lightly moistened with isopropyl alcohol

STORAGE CONDITIONS

Storage	Only in its original case in a clean, dry environment
Temperature	+10°C → +40°C (+50°F → +104°F)
Relative humidity	< 90% - non-condensing
Pressure	690-1075 hPa (10-15.6 psi)
Bending radius	50 mm min.

CONTENTS LIST

Probe	Delivered with a routine test report
Other parts (for vac line only)	1 vacuum feed-through, 1 KF16 O ring, 1 KF16 clamp
Transport case (up to 3 probes)	Drip-proof and dust-proof case (W = 430 mm - D = 330 mm - H = 110 mm - Weight: 2200 g)
Protection tool used for handling	Protective foam
User guide	cf. eoSense User Guide PDF file GU-eoSense

COMPATIBLE DEVICES & ACCESSORIES

Optoelectronic converter	eoSense (cf. related data sheet FT-eoSense)
Holder	eoPod (cf. related data sheet FT-eoPod)
Calibration cell	eoCal (cf. related data sheet FT-eoCal)
Fibre extension	eoLink (cf. related data sheet FT-eoLink)
Vacuum feed-through	eoVac (cf. related data sheet FT-eoVac)
Cartesian robot	eoScan (cf. related data sheet FT-eoScan)

APPLICATIONS INFORMATION

Standard setup

Recommended setup in most cases

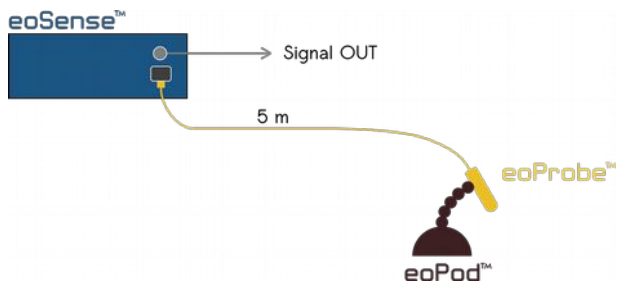

Calibration setup

Required setup for probe (re)calibration in air or in any fluid - refer to eoCal™ data sheet

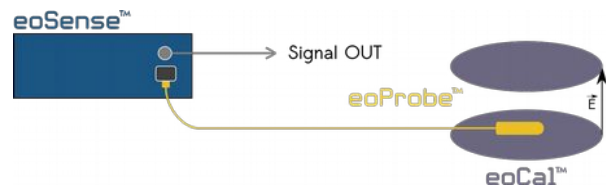

Remote setup

Required setup from a great distance, like outdoor conditions

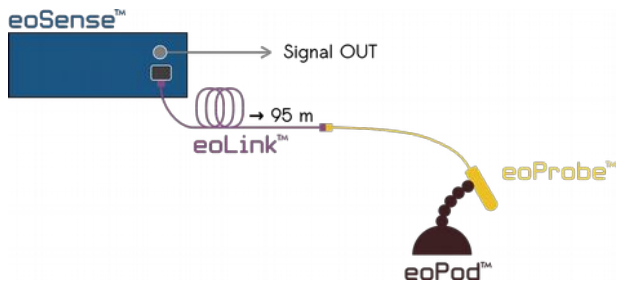

Low to medium vacuum setup

Required setup for measurements down to 1 hPa (1 mbar)

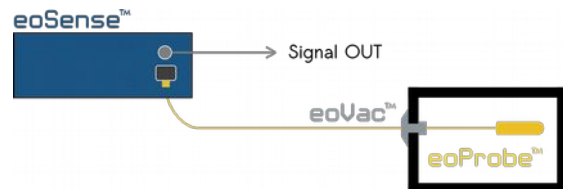

Medium to high vacuum setup

Required setup for measurements down to 1 mPa (10^{-5} mbar) with specific vac line

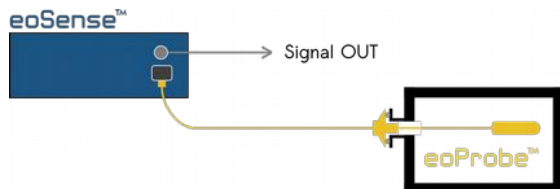

Field mapping setup

Required setup for 1D, 2D & 3D field mapping

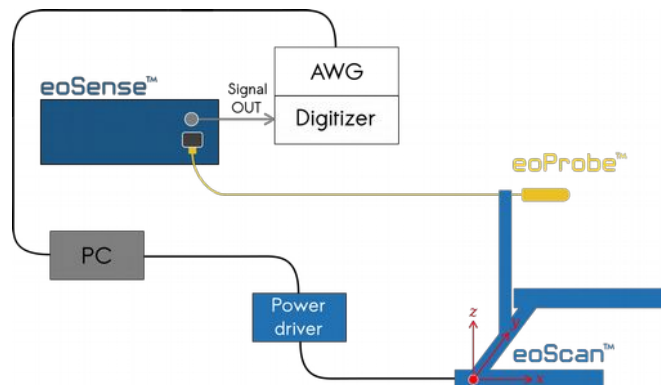

Probe response vs E field strength

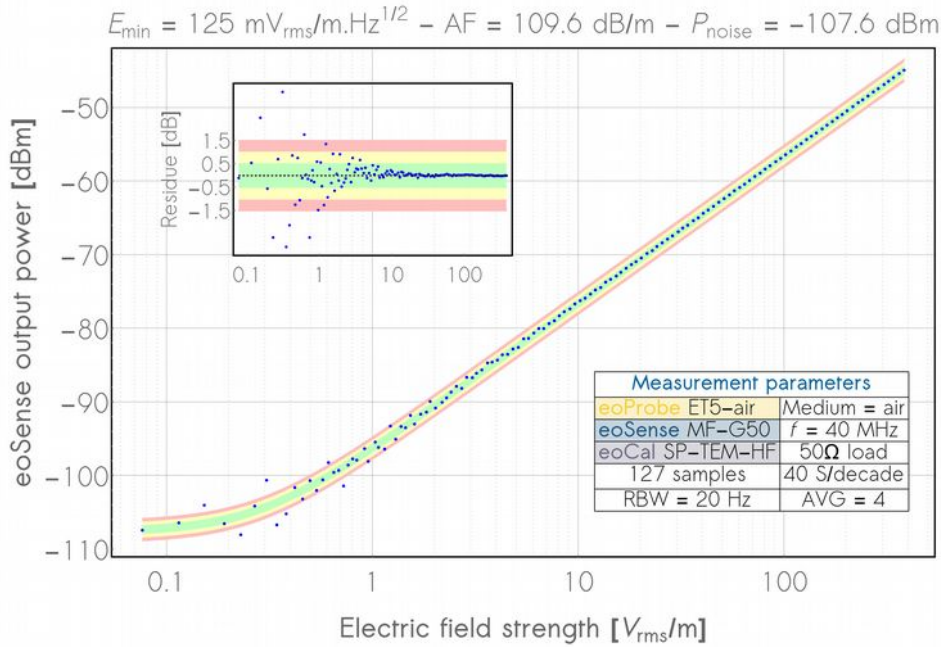

- Dynamic range lower bound → eoSense noise floor (-107.6 dBm)
- Min. measurable E field E_{min} → E field strength at intersection of noise floor and eoProbe linear response given in a 1-Hz RBW¹ (irrespective of frequency)
- Deviation from linearity → < 0.1 dB for E field strength > 10 V_{rms}/m (see graph inset showing the residue²)

¹ Resolution Band Width

² Difference between measurement and theoretical fit

Probe response vs frequency

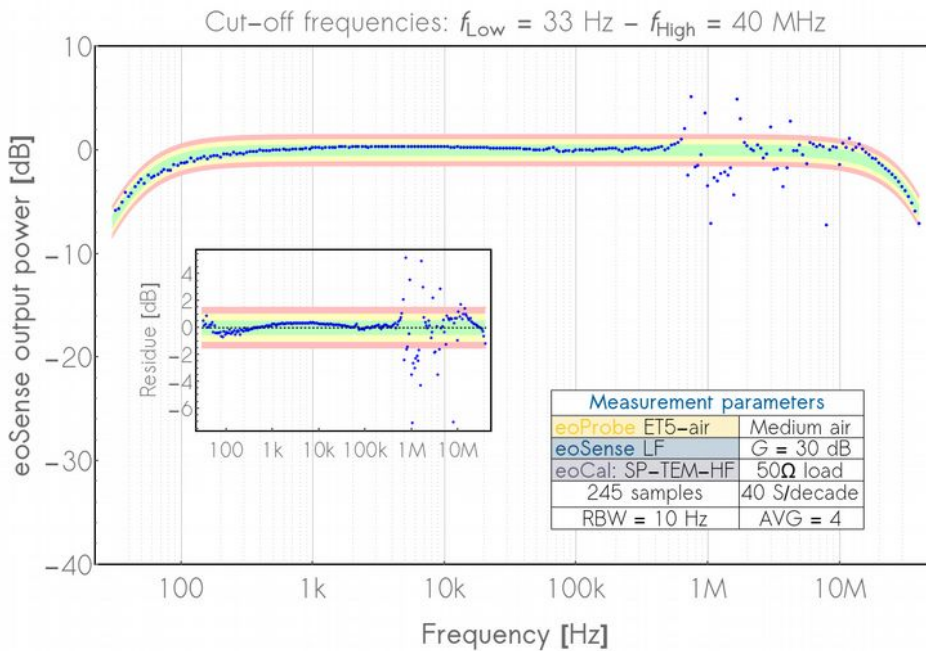

- Composite frequency response → eoProbe™ + eoSense™
- Cut-off (-3dB) frequencies (33 Hz & 40 MHz) → linked only to converter eoSense™ (specified bandwidth of 40 Hz - 30 MHz)
- Flat frequency response ($\pm 1.5 \text{ dB}$) except some (< 20) narrow (< 20 kHz) resonances and antiresonances in the 600 kHz - 15 MHz band width → stationary piezoelectric resonances of the electro-optic transducer

Probe response vs E field angle

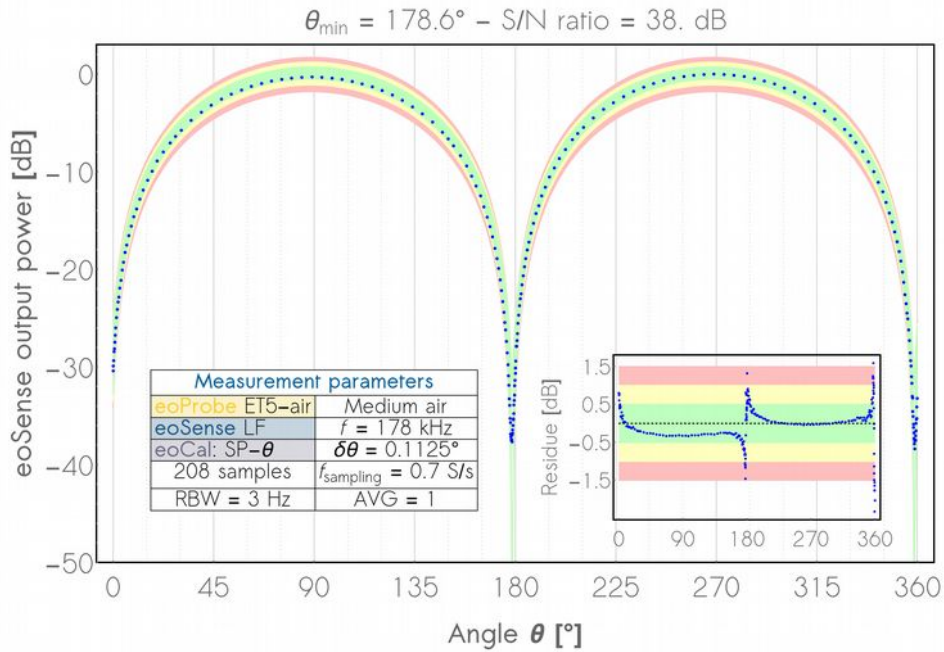

- Single E field component transducer → purely sinusoidal scalar response
- High rejection ratio of the orthogonal E field components → 38 dB (limited by noise floor of production setup)
- Precise orientation of probe sensitivity axis → misalignment of 1.4°

Probe response vs wave incidence angle

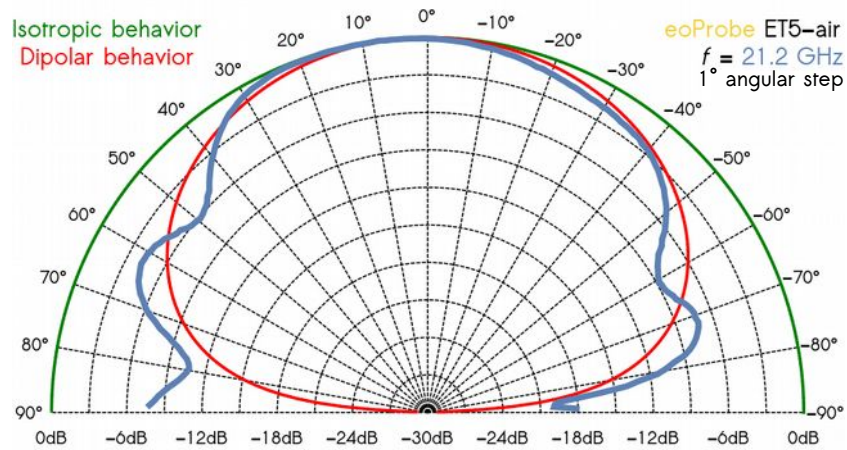

- Low frequency behaviour → receiving pattern close to that of isotropic antenna
- High frequency behaviour → receiving pattern in between that of isotropic antenna and dipolar antenna (case for RF signal wavelength comparable to eoProbe size - for $f > 5 \text{ GHz}$)
- High -3 dB acceptance angle → 80° at 21.2 GHz (see Fig. above)



Kapteos SAS
Bâtiment Cleanspace
354 voie Magellan
73800 Sainte-Hélène du Lac
FRANCE

Email: contact@kapteos.com
☎ +33 (0)4 79 62 88 34

Follow us on



Our website



www.kapteos.com